

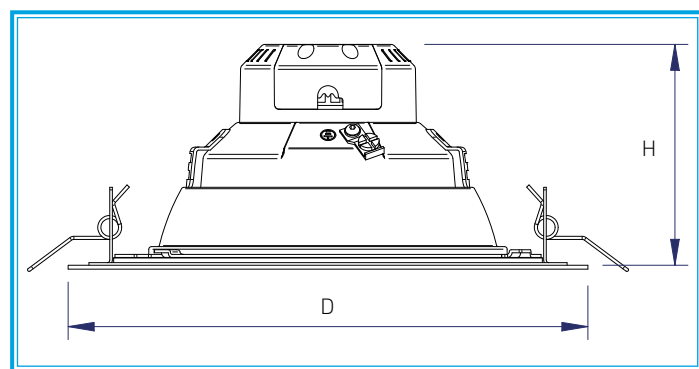



**DESRIPTIF**

- Réflecteur aluminium brillant à facettes
- Fermeture du bloc optique en verre trempé
- Appareillage LED intégrée, non gradable
- Corps et collerette en acier et aluminium laqué
- Montage sans outil par ressorts pour plafond d'épaisseur 10 à 30mm



**LES PLUS**  
Économique  
Faible hauteur  
IP 44

**CARACTÉRISTIQUES TECHNIQUES**

960° IP44  30000 h. (L70B50)

Puissance :

12W 23W

Faisceau :

89°

I.R.C. :

IRC 80

Température de couleur :

3000 K 4000 K





12W	Teinte	Faisceau	Code
	830		A40 135 01
	840	Flood	A40 135 02

23W	Teinte	Faisceau	Code
	830		H16C11 02
	840	Flood	H16C11 01

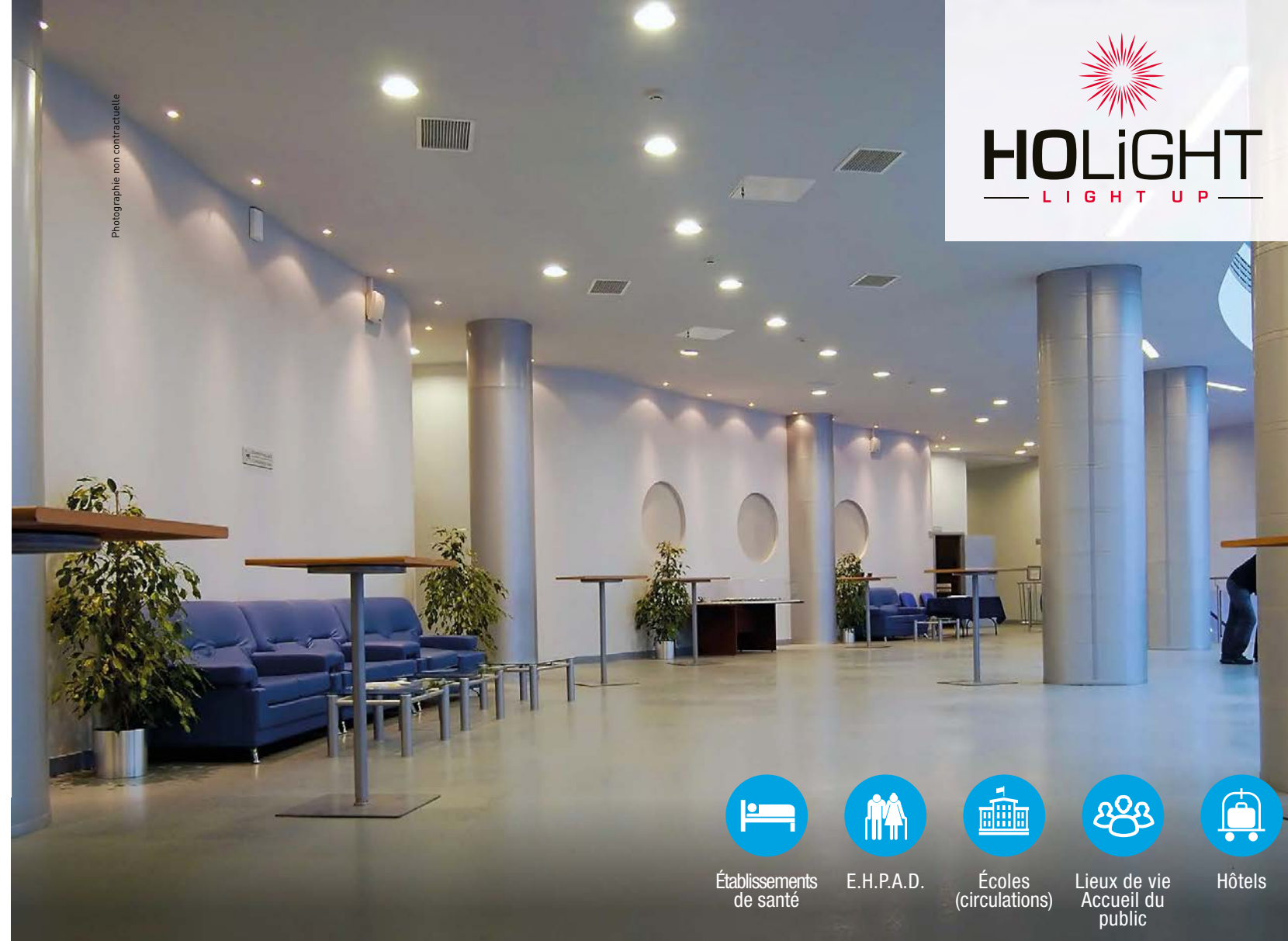
Puissance	Température de couleur	Flux
12 W	3000 K	1020 lm
	4000 K	1070 lm
23 W	3000 K	2040 lm
	4000 K	2160 lm

Puissance	Diamètre extérieur	Diamètre encastrement	Hauteur
12 W	150 mm	140 mm	75 mm
23 W	200 mm	190 mm	85 mm



-  Établissements de santé
-  E.H.P.A.D.
-  Écoles (circulations)
-  Lieux de vie Accueil du public
-  Hôtels

**OPTIONS**

• Finition :



**ACCESSOIRES**

• Accessoires de montage

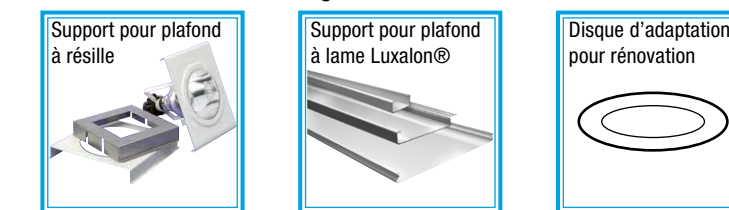

• Réservation béton

